

# 7605D125VDCDXXWP

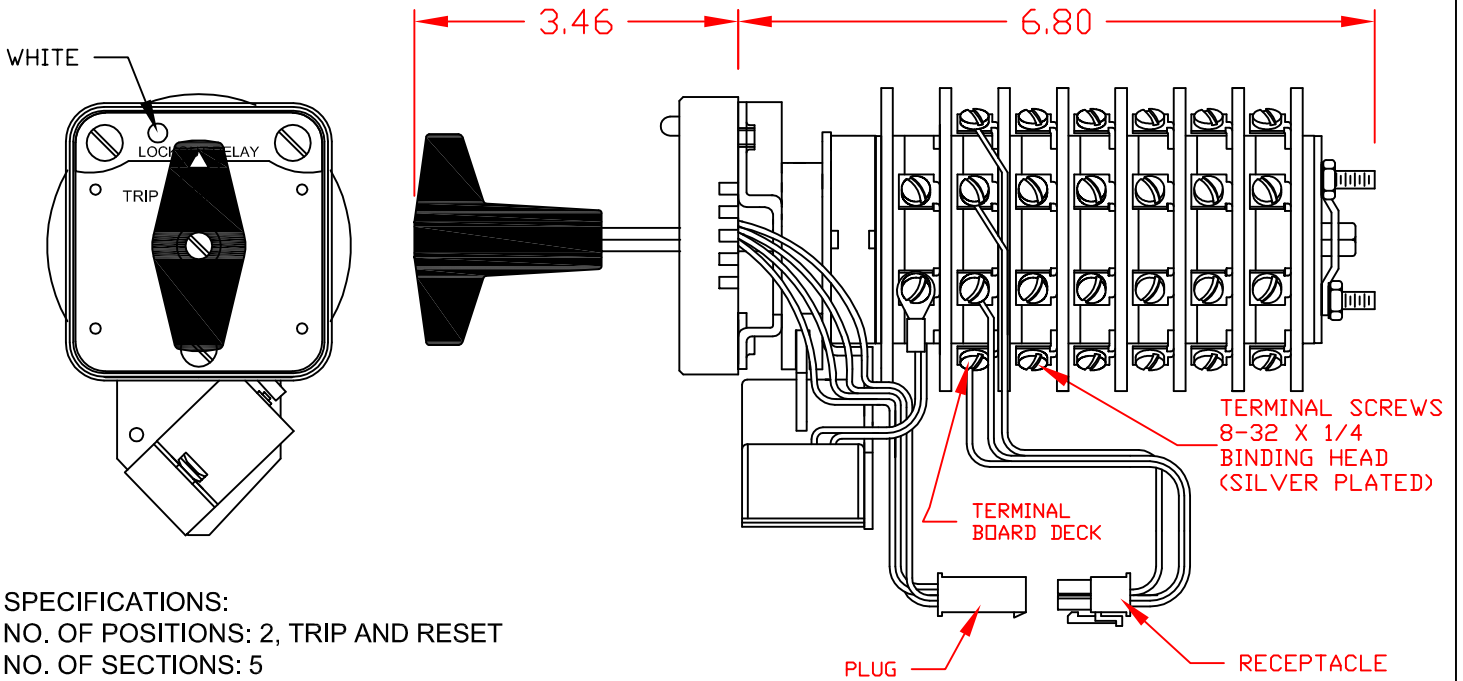

**SPECIFICATIONS:**

NO. OF POSITIONS: 2, TRIP AND RESET

NO. OF SECTIONS: 5

CONTACTS: 2 NORMALLY OPEN  
2 NORMALLY CLOSED  
PER DECK

ACTION: 45° POSITIVE TRIP DETENT

STATIONARY CONTACTS : SILVER OVER COPPER

NAMEPLATE: AS SHOWN

**COIL SPECIFICATIONS:**

OPERATING VOLTAGE: 125 VDC / 120 VAC

THRESHOLD VOLTAGE: 16 VDC / 20 VAC

OPERATING RANGE: 30 - 140 VDC / 30 - 140 VAC

CURRENT AT RATED VOLTAGE: 4.6 / 4.4 AMPS

**ELECTRICAL RATINGS:**

25 A/120 VAC 3 A/ 125 VDC

15 A/240 VAC 1 A/ 250 VDC

6 A/600 VAC



**OVERLOAD CURRENT**

(50 OPERATIONS):

95 A/120 VAC

65 A/240 VAC

35 A/600 VAC

DIELECTRIC STRENGTH: 2200 VRMS

INSULATION RESISTANCE: 100 MEGOHMS INITIAL

CONTACT RESISTANCE: 10 MILLIOHMS MAX. INITIAL

DECK	CONTACTS	POSITION	
		TRIP	RESET
1	11 ->    -> 13	X	X
	12 ->    -> 18	X	X
	15 ->    -> 17	X	X
	16 ->    -> 14	X	X
2	21 ->    -> 23	X	X
	22 ->    -> 28	X	X
	25 ->    -> 27	X	X
	26 ->    -> 24	X	X
3	31 ->    -> 33	X	X
	32 ->    -> 38	X	X
	35 ->    -> 37	X	X
	36 ->    -> 34	X	X
4	41 ->    -> 43	X	X
	42 ->    -> 48	X	X
	45 ->    -> 47	X	X
	46 ->    -> 44	X	X
5	51 ->    -> 53	X	X
	52 ->    -> 58	X	X
	55 ->    -> 57	X	X
	56 ->    -> 54	X	X

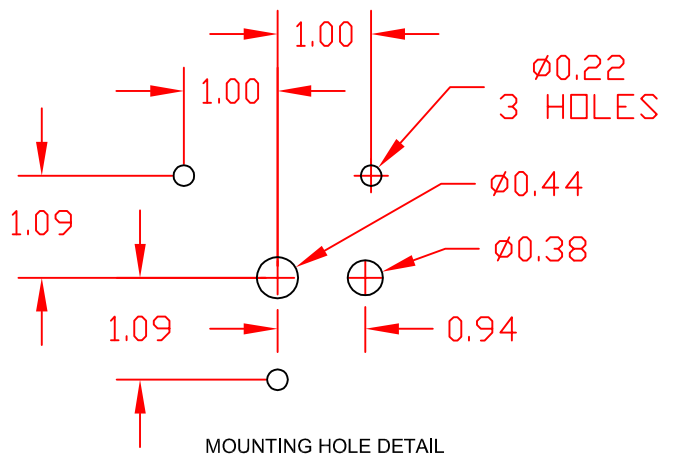

**DESCRIPTION**

7605D125VDCDXXWP



308 COMPONENTS DRIVE  
SMITHFIELD, NC 27577 USA

LOCK-OUT RELAYS (LOR)

GENERAL OPERATION:

THE HANDLE OF THE LOR MUST BE MANUALLY ROTATED CLOCKWISE TO PLACE THE UNIT IN THE "RESET" POSITION (SEE FIGURE A)

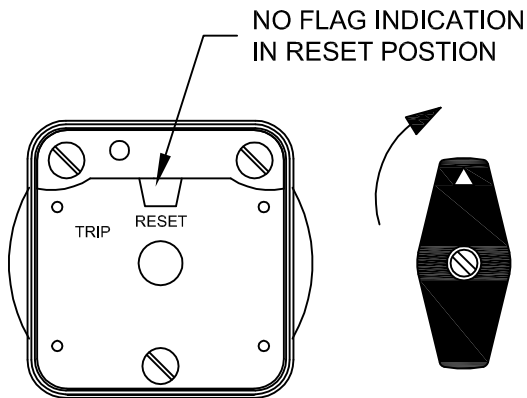
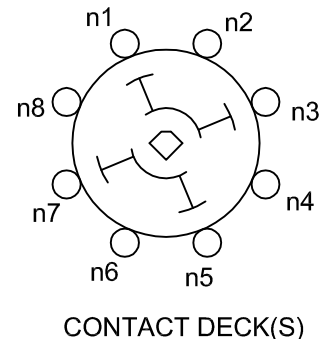
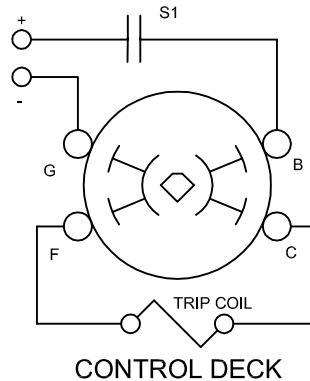

FIGURE A - RESET POSITION



WHEN A PREDETERMINED CONDITION EXISTS, A SIGNAL WILL BE SENT TO S1 WHICH WILL ACTIVATE THE COIL AND CAUSE THE LOR TO "TRIP". THE "B" AND "G" CONTACTS ON THE CONTROL DECK PROVIDE THE CONNECTION TO THE CONTROL CIRCUIT THROUGH S1 WHICH CAN BE A CONTACT OF ANY TYPE I.E. SWITCH, RELAY.... THE LOR CONTACTS IN FIGURE "B" ARE IN THE "TRIPPED" POSITION.

THE LOR WILL REMAIN IN THE "TRIPPED" POSITION UNTIL MANUALLY RESET.

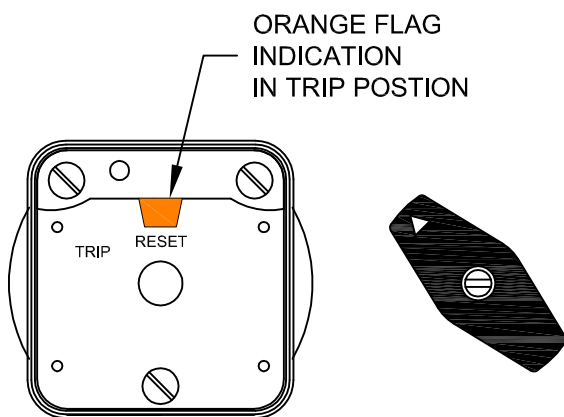
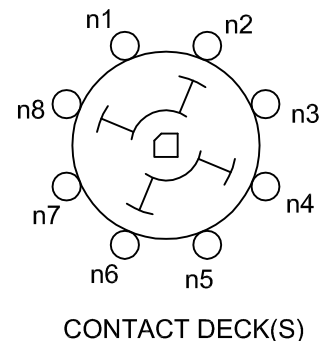
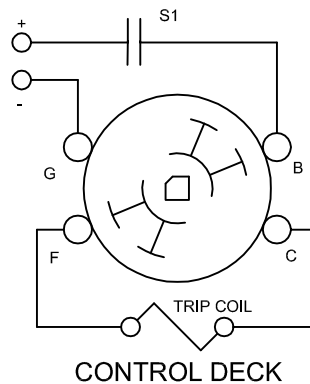

FIGURE B - TRIP POSITION



DESCRIPTION

7605D125VDCDXXWP

## LED INDICATION

CONDITION #1	
ROTOR	RESET (AS SHOWN)
SWITCH 1 (S1)	OPEN

RESULT	
LEFT LED	ON
SCADA CIRCUIT TRIP COIL MONITOR	OPEN

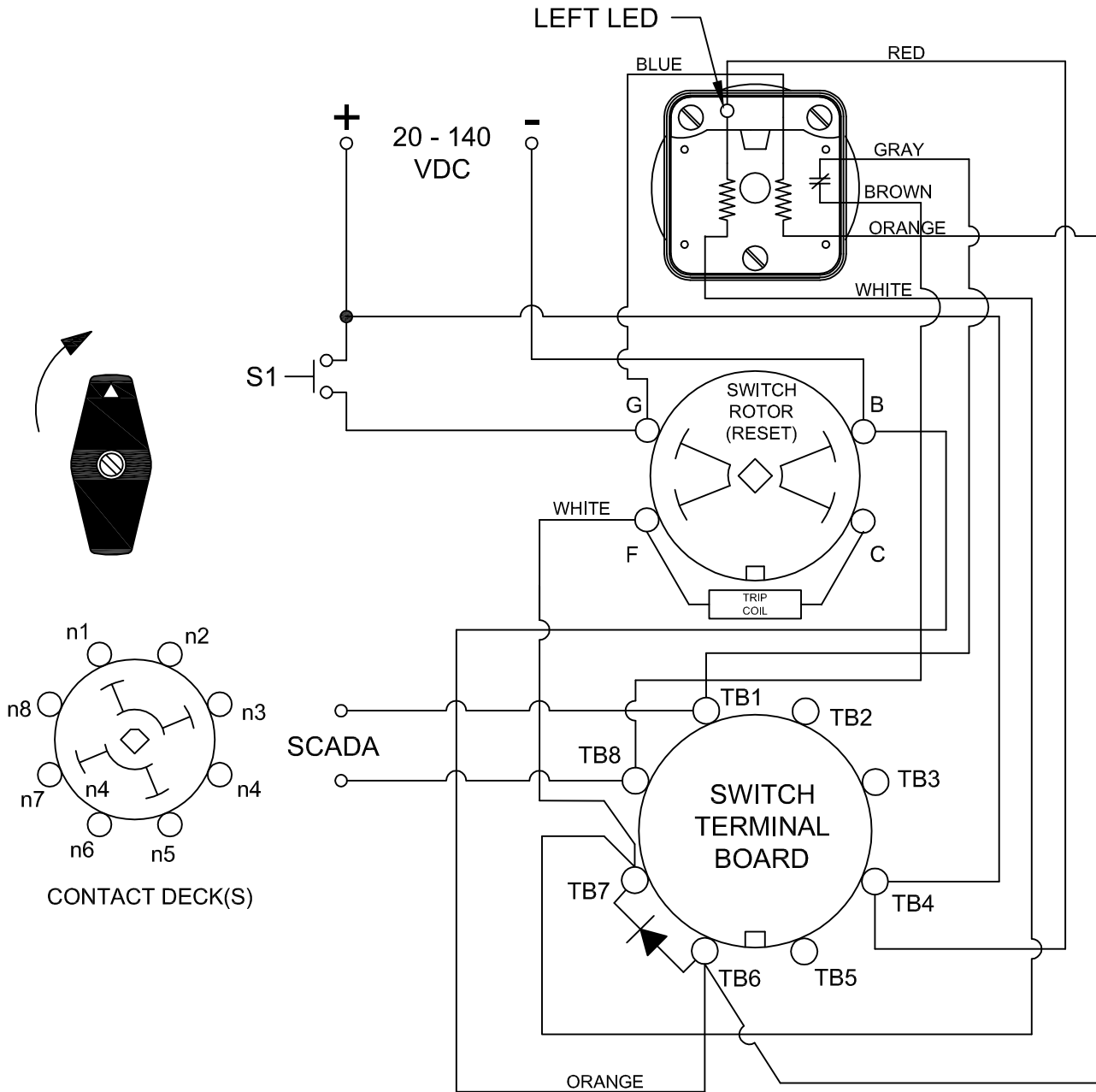

## DESCRIPTION

7605D125VDCDXXWP

## LED INDICATION

CONDITION #2	
ROTOR	TRIP( AS SHOWN)
SWITCH 1 (S1)	CLOSED

RESULT	
LEFT LED	OFF
SCADA SWITCH	CLOSED

WHEN S1 CLOSSES, THE COIL CAUSES A MECHANICAL ROTATION OF THE RELAY RESULTING IN THE SWITCH ROTOR ADVANCE TO THE "TRIP" POSITION SHOWN

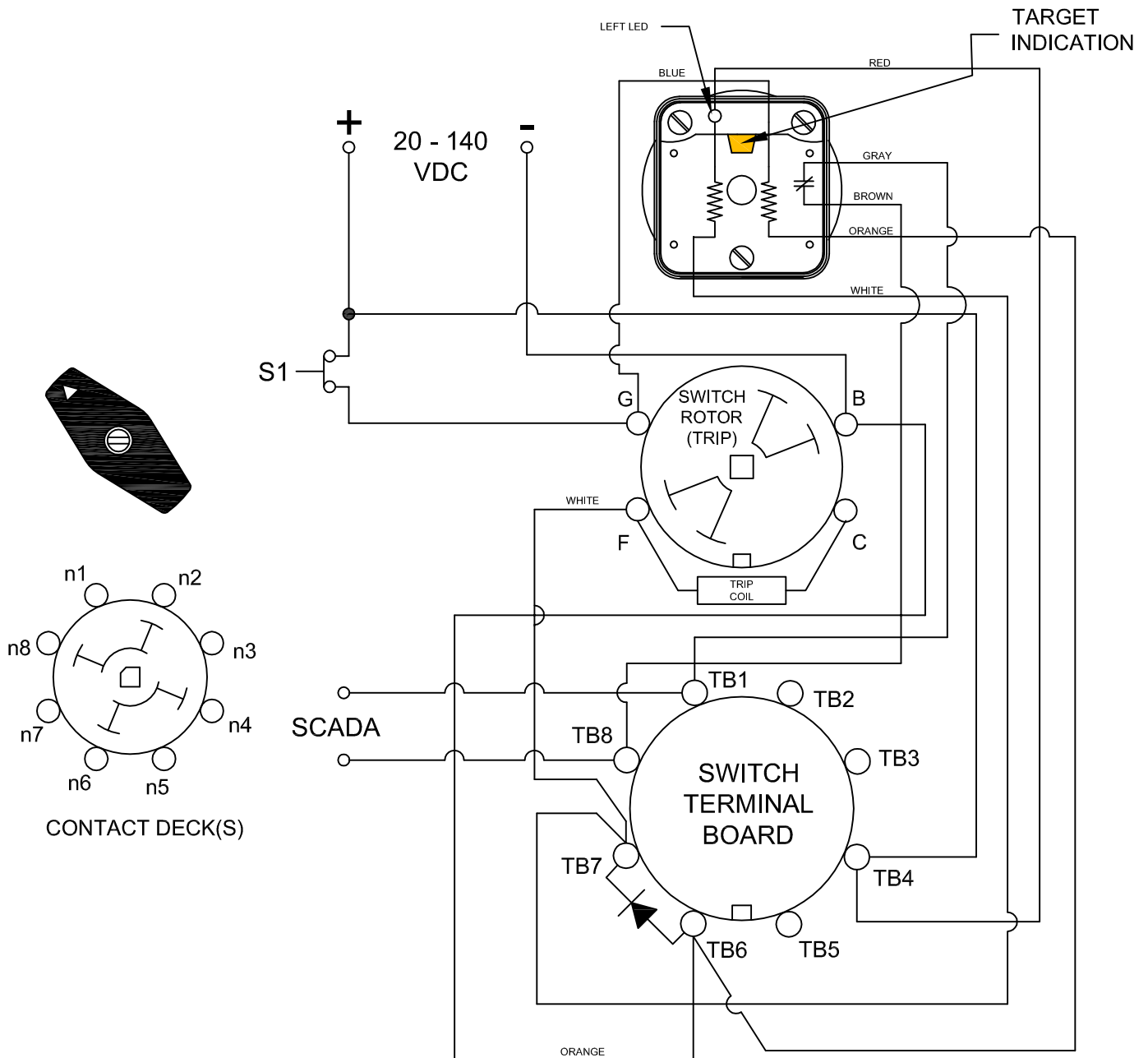

## DESCRIPTION

7605D125VDCDXXWP

LED INDICATION

CONDITION #2	
ROTOR	TRIP (AS SHOWN)
SWITCH 1 (S1)	OPEN

RESULT	
LEFT LED	OFF
SCADA SWITCH	CLOSED

WHEN S1 OPENS THE LOR WILL REMAIN IN THE TRIPPED POSITION AND THE SCADA CIRCUIT WILL REMAIN CLOSED UNTIL THE LOR IS ROTATED BACK INTO THE RESET POSITION

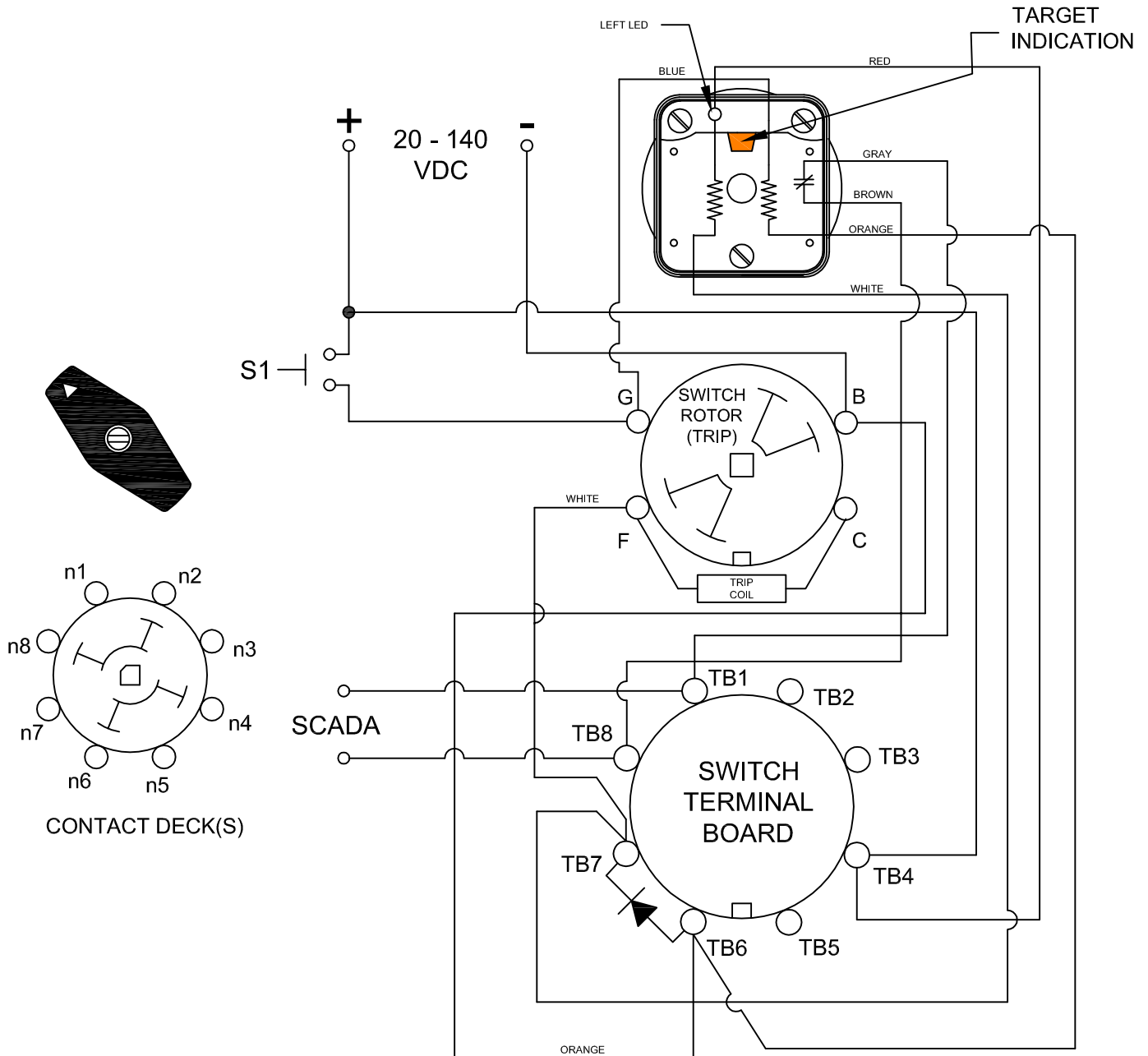

DESCRIPTION

7605D125VDCDXXWP